

Incremental Rotation Sensor

Rotary speed sensor, angle displacement sensor

Model 8821

Code:	8821 EN
Delivery:	ex stock/3 weeks
Warranty:	24 months

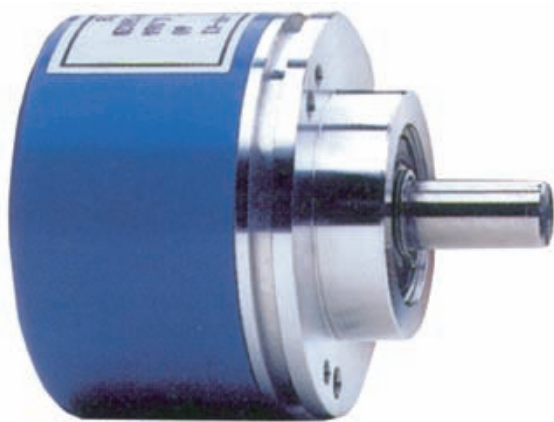

- Supply voltage 10 ... 30 V DC
- Degree of protection IP65, all-around
- Robust
- High resistance to interference

Rotary speed sensor

- 60 pulses/turn (standard)
- Max. 8000 rpm

Angular displacement sensor

- 360 pulses/turn (standard)
- Detection of rotation direction (channels A and B)
- Reference pulse (channel N)

Special versions on request

(higher pulse rate, TTL output etc.)

Application

Incremental rotation sensors are used wherever displacement, positions or speeds have to be measured accurately. They are therefore important interfaces between the mechanical and electronic parts of a machine.

Mechanically robust, electrically reliable and resistant to extreme ambient conditions; these are the outstanding properties offered by this sensor.

Typical applications include:

- ▶ Machine tools
- ▶ Wood and plastic machining
- ▶ Textile machines
- ▶ Lifts
- ▶ Door systems
- ▶ Paper machines
- ▶ Drive equipment
- ▶ Assembly and handling equipment
- ▶ Packaging machines
- ▶ Scales
- ▶ Test machines
- ▶ Conveying equipment
- ▶ Doors and gates

Description

Model 8821 rotation sensor generates rectangular electrical pulses when the shaft is turned. An encoder disk is coupled to the shaft which is carried on 2 ball bearings. The light from an infrared diode passes through the encoder disk and the diaphragm disk (which is only present on the angle sensors). The signals picked up by light-sensitive sensors are processed to yield rectangular signals.

The aperture disk generates an offset in the pulse sequences (only on angle sensors).

Angle sensor

The rectangular pulses are output from channels A and B with a displacement of a quarter of a pulse (90°). This displacement allows the evaluation electronics to detect the direction of rotation. Electrical faults and vibrations do not lead to incorrect counts.

An early warning output indicates that the light intensity is weakening. After this, the sensor can still be operated for some thousands of hours before it fails.

A reference pulse, N, is also output. This is a single pulse for each rotation.

Technical Data

Electrical values

Range of excitation voltage U_B : standard 10 ... 30 V DC
(optional 5 V DC, refer to order code)

Current consumption: max. 60 mA

Outputs:

- Channel A : speed sensor pulse
- Channel A and B : angle displacement sensor pulse
- Channel N : reference pulse (angle displacement sensor)
- Max current : max. 40 mA
- Pulse level : $H > U_B - 2.5 \text{ V DC}$
- : $L < 2.5 \text{ V DC}$
- Pulse frequency : max. 200 kHz

Protection against polarity reversal.

Early-warning system:

The output is LOW, if the light source has lost approx. 90 % of its luminosity (NPN OC, max. 30 V, 10 mA).

Environmental conditions

Nominal temperature range: -10 °C ... +70 °C

Storage temperature range: -30 °C ... +80 °C

Mechanical values

Dimensions: see drawing

Shaft: material stainless steel
axial load max. 120 N
radial load max. 220 N
break away torque 1 Ncm

Housing: clamping flange aluminium
rear side covered aluminium

Bearing: model 2 precision ball bearings
durability 10⁹ cycles at 100 % bearing load
 10¹⁰ cycles at 40 % bearing load
 11¹¹ cycles at 20 % bearing load

Rotation speed: max. 8000 RPM

Weight: 250 g

Vibration: 50 m/s² (20 Hz ... 1000 Hz)

Shock: 1000 m/s² (11 ms)

Protection class: acc. to EN 60529 shaft side IP65 rear side IP67

Electrical connection:

PG screw joint with shielded PVC cable, length 2 m, diameter approx. 6 mm, bending radius $\geq 20 \text{ mm}$, conductor cross section 0.14 mm².

Wiring code:

- Excitation voltage (-) white
- Excitation voltage (+) brown
- A green
- B yellow
- N grey
- Output early warning pink
- Shield strand

Shield open at sensor.

Standard wiring

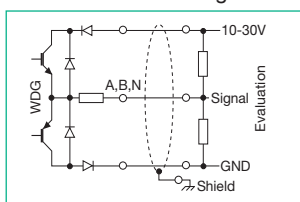

Pulse diagram (angle displacement sensor)

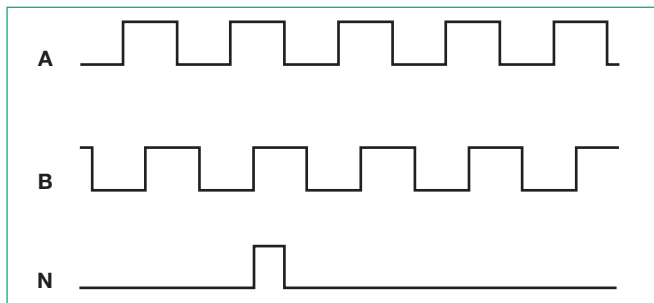

View to shaft, clockwise rotation

Dimensional drawing model 8821

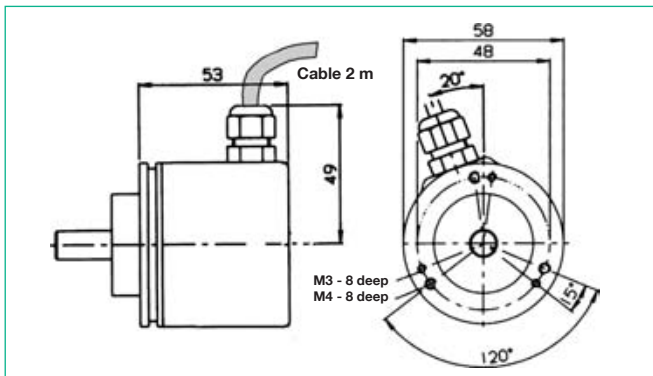

Accuracy

1. Pitch error Deviation of a flank to its exact geometrical position max. 12 % of a pitch length
2. Relation of pulse and pause Relation of pulse and pause error based on pitch max. $\pm 7 \%$
3. Displacement of phase Fluctuation in the distance between two following flanks of channel A and B around nominal distance 90°; max. fluctuation: $\pm 7.5 \%$ of a pitch

Pitch: Pulse + pause

Optics

- Light source: infrared - LED
- Durability: typically 100 000 hours
- Sampling: differential

Order Information

Version with excitation voltage 10-30 V DC (standard)

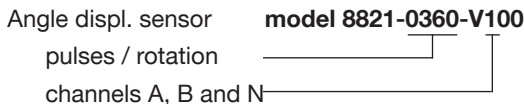
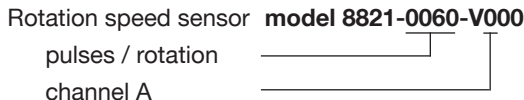

Version with excitation voltage 5 V

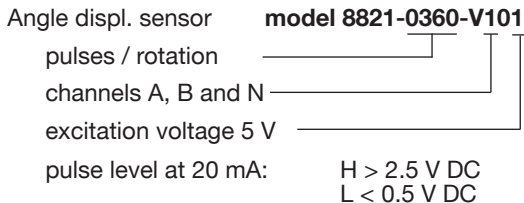

Accessories

Evaluation electronics with indication of rotation speed or angle displacement, like indicator model 9180-V5000 (at rotational speed: minimum 1 pulse/s) on request